

# Shamrock

March 4th 2014

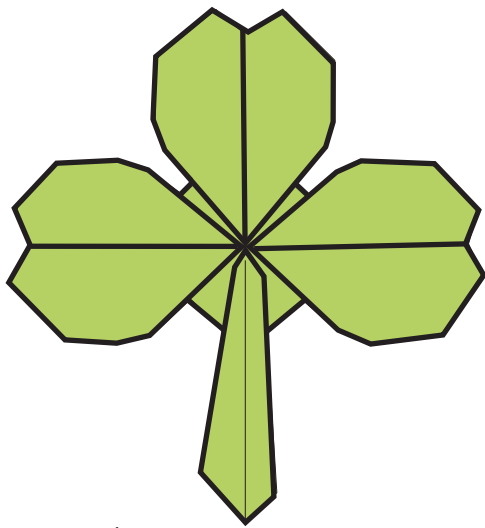

*Shamrock*

© Max Hulme

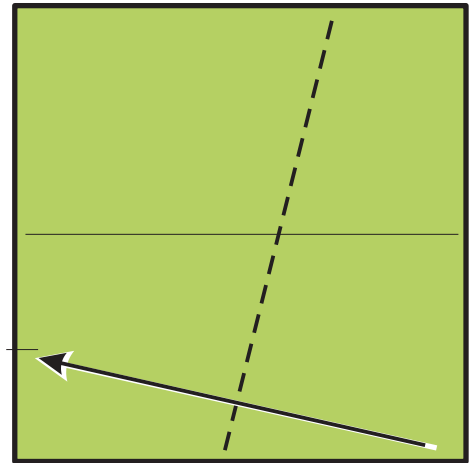

mark on top edge

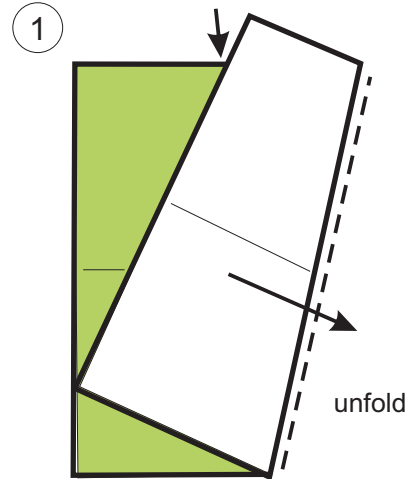

2

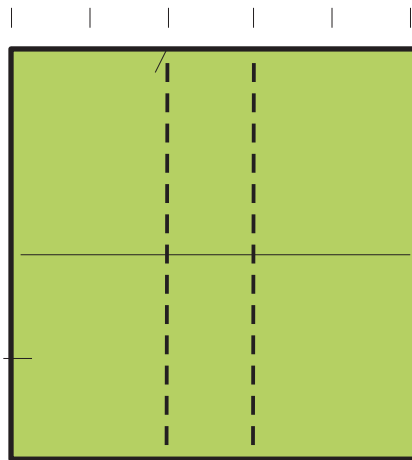

3

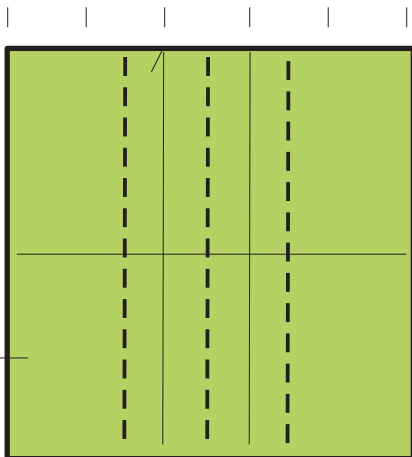

4

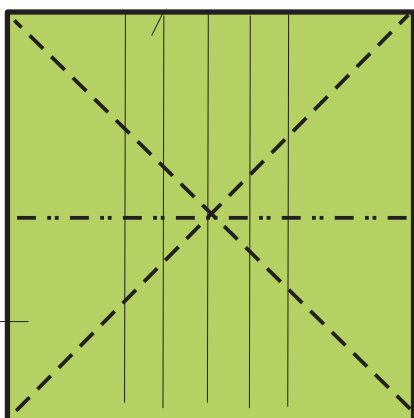

5

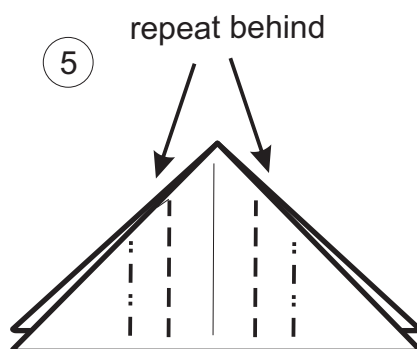

6

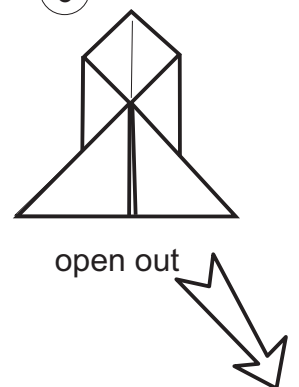

# Shamrock

7

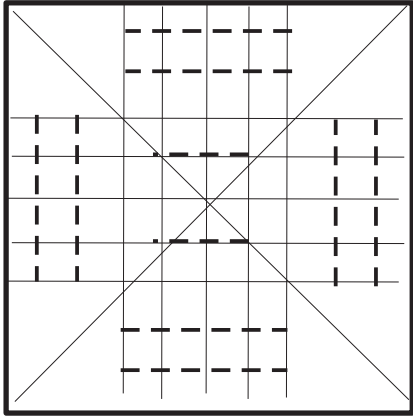

8

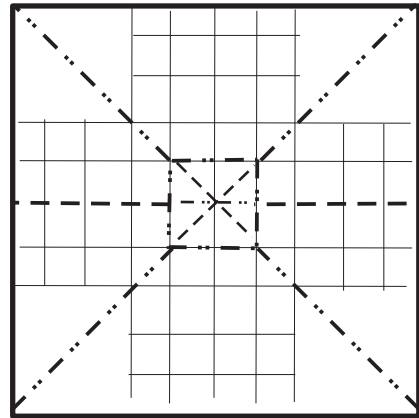

9

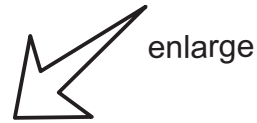
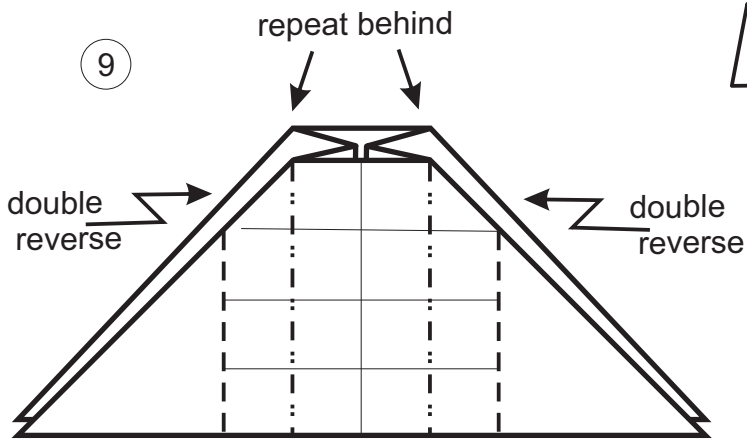

10

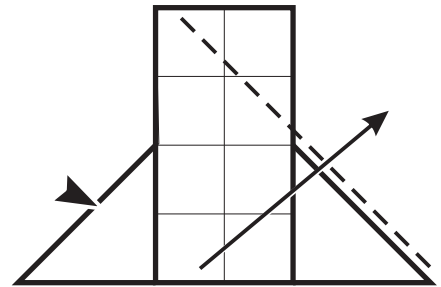

11

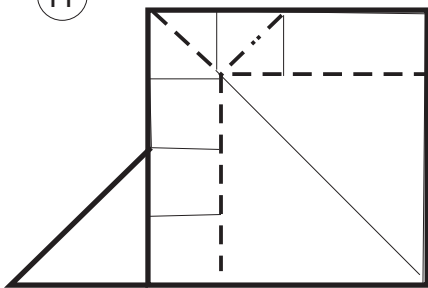

12

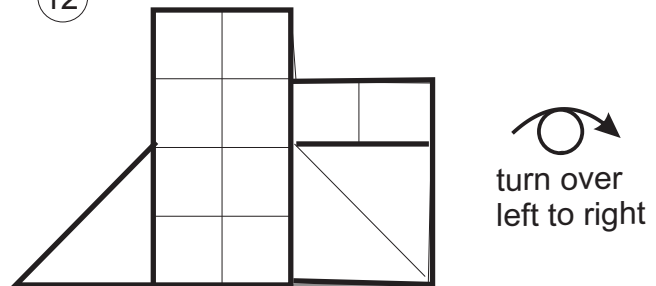

13

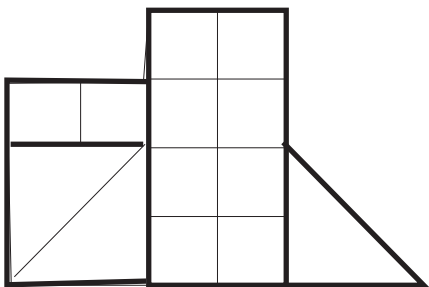

repeat steps 10 and 11

14

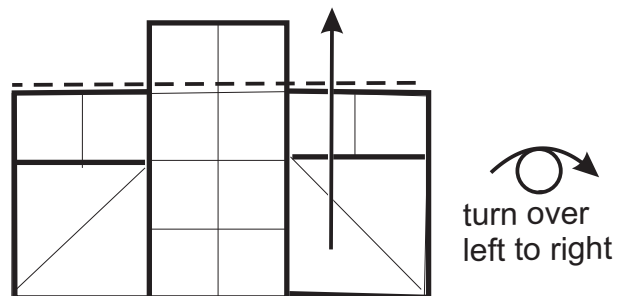

# Shamrock

15

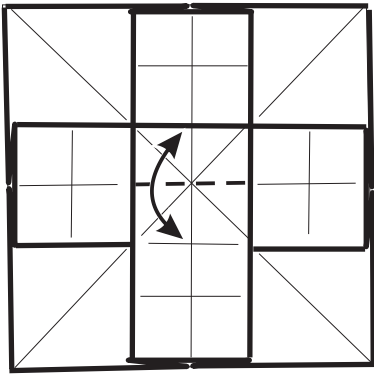

16

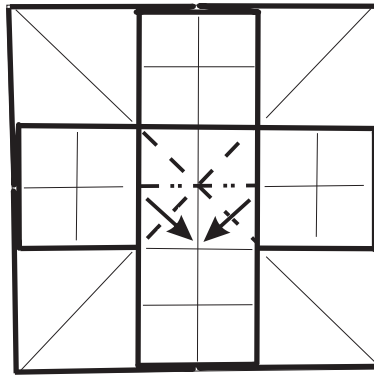

fold top layer only

17

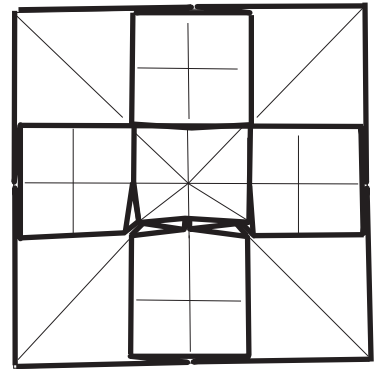

18

rotate  
1/2 turn

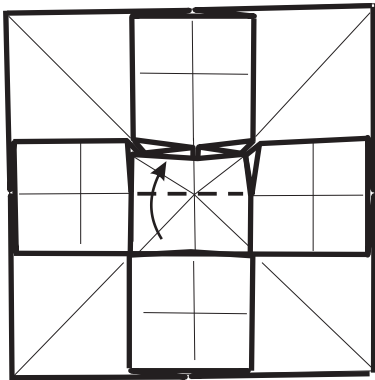

19

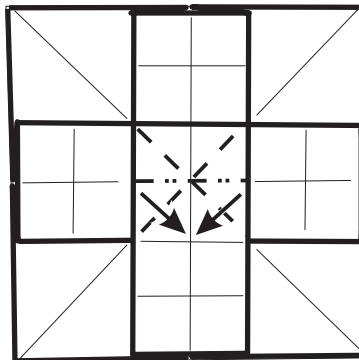

20

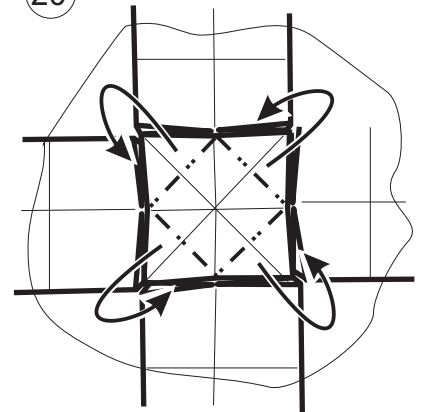

fold corners under

21

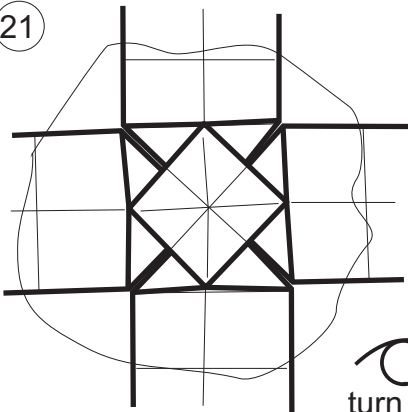

turn over

22

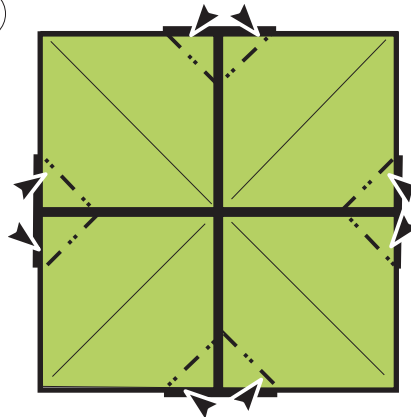

23

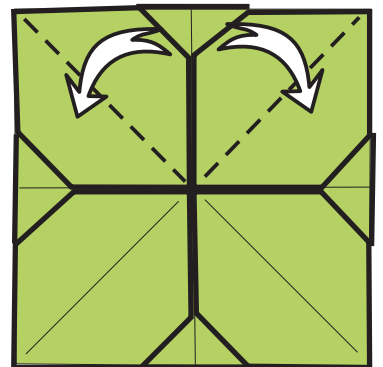

24

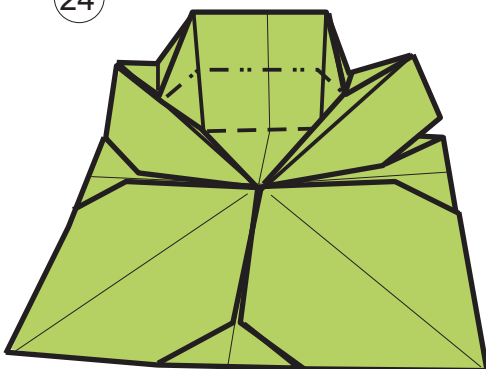

25

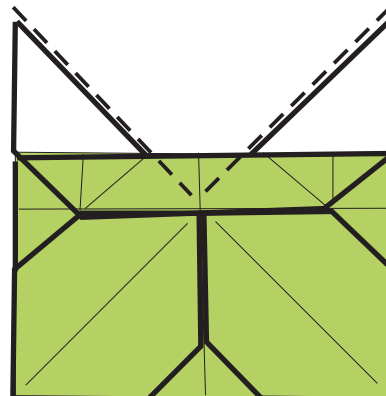

# Shamrock

26

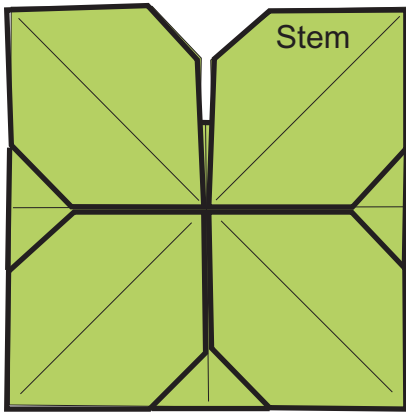

repeat steps 23 to 25 to the right hand side

27

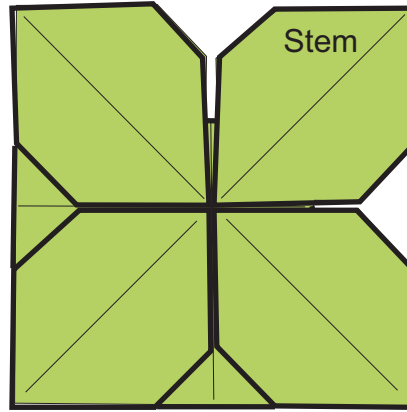

turn over

28

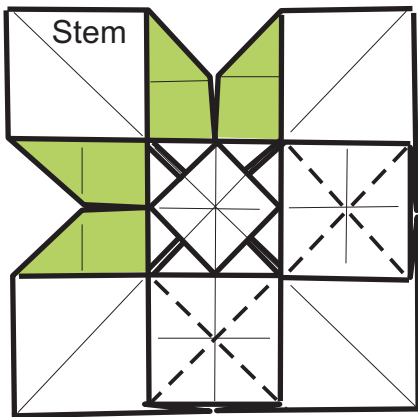

29

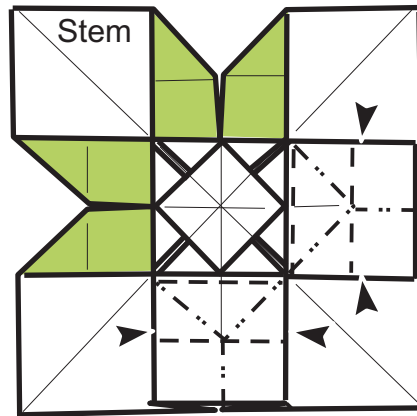

30

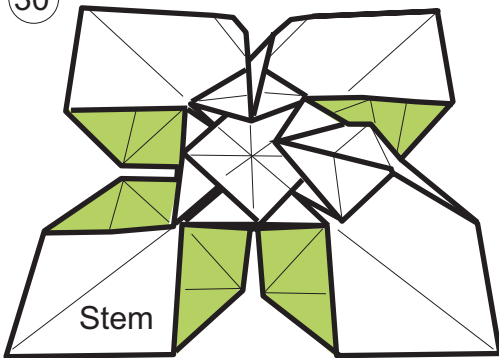

31

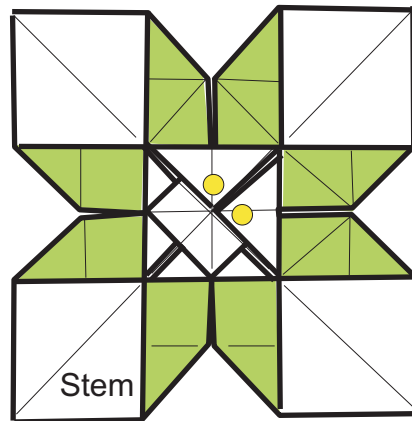

tuck the corners marked ● into the pockets underneath

31

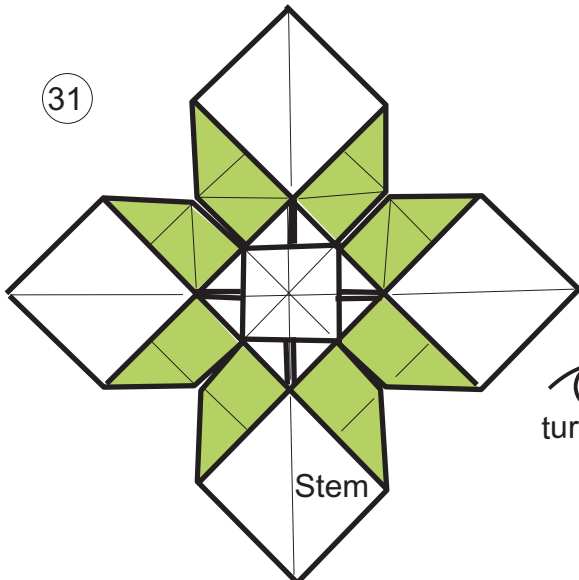

turn over

32

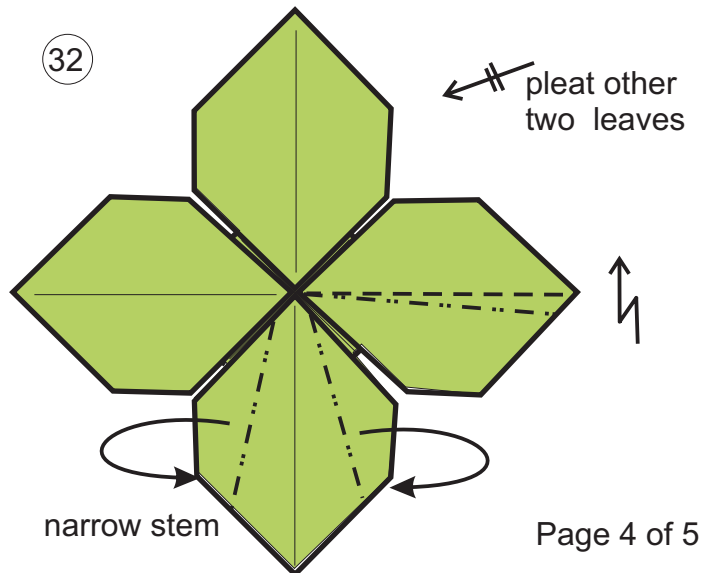

pleat other two leaves

narrow stem

# Shamrock

