

THE BRITISH FLAG

OTHERWISE KNOWN AS THE
THE UNION FLAG OR THE UNION JACK

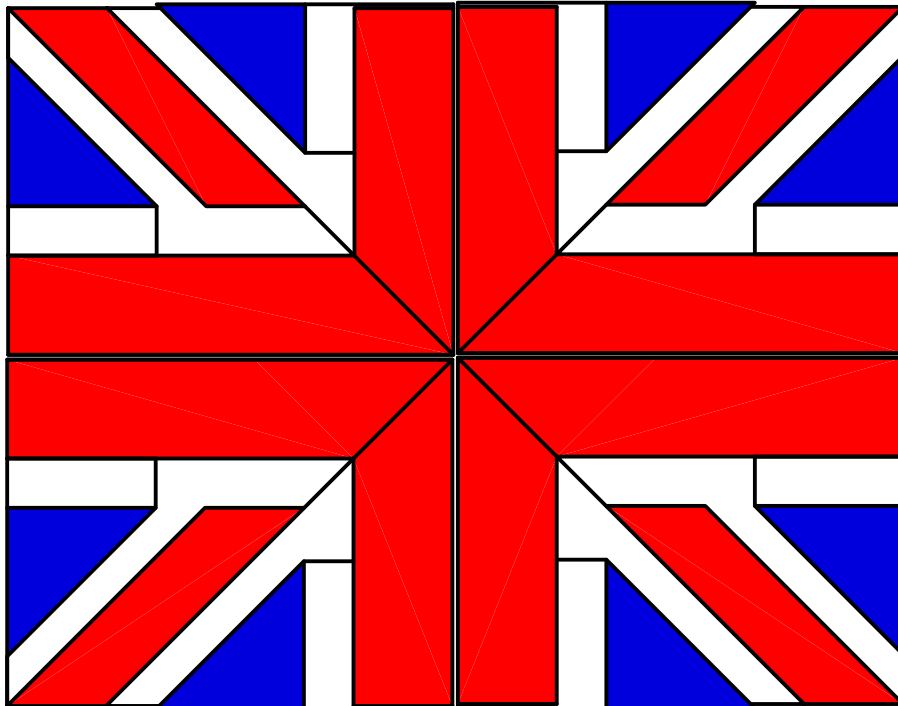

ORIGAMI ADAPTATION AND DRAWING BY MICK GUY

THE UNION FLAG BY MICK GUY

The flag comprises four modules and each requires a red and a blue 15cm square.
The resulting flag size will be about 17cm x 13cm (6.75" x 5")

red squares x 4
white side up

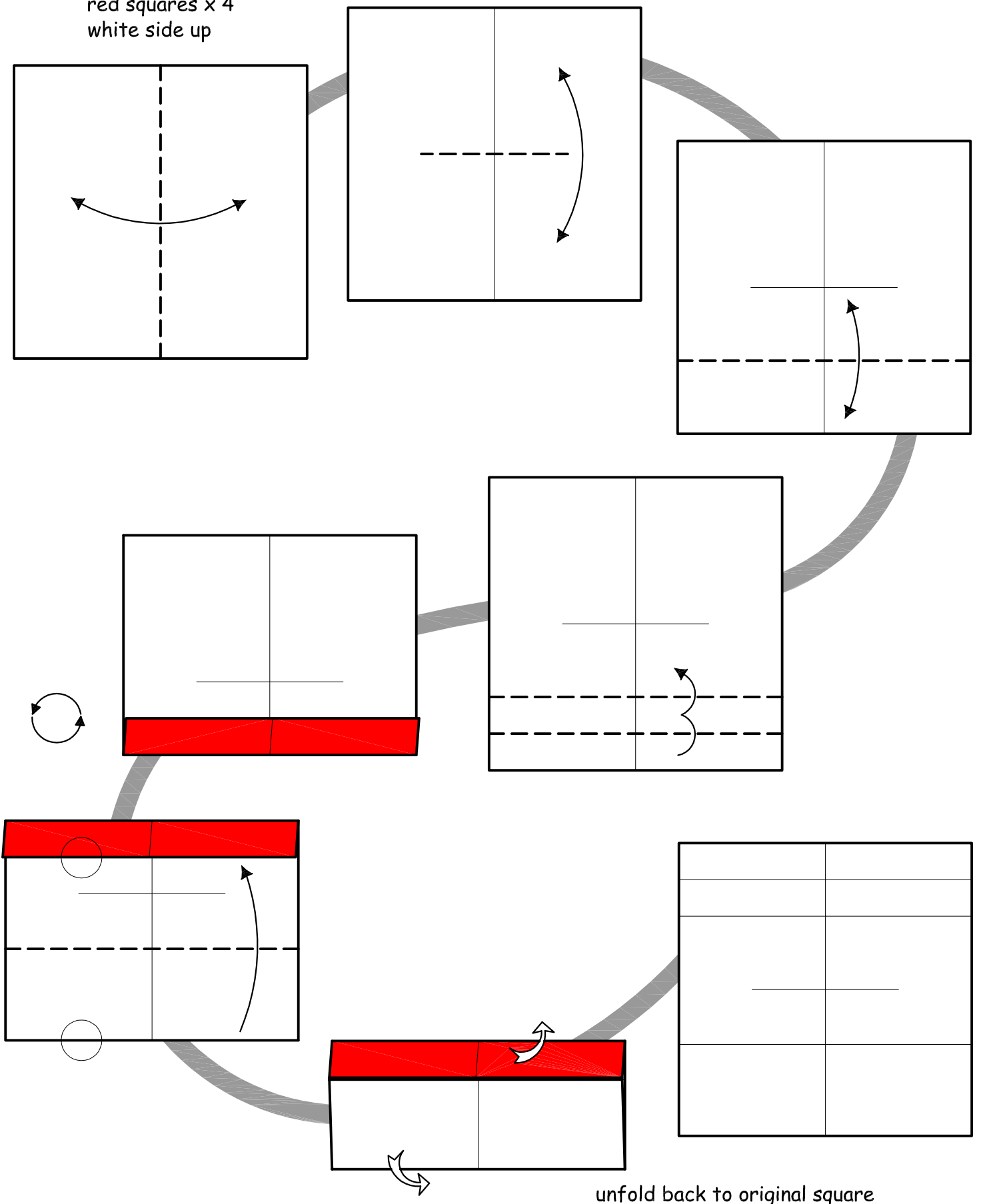

THE UNION FLAG PAGE 3

This sequence makes the bottom left and top right modules
(St. George and St. Patrick's Crosses)

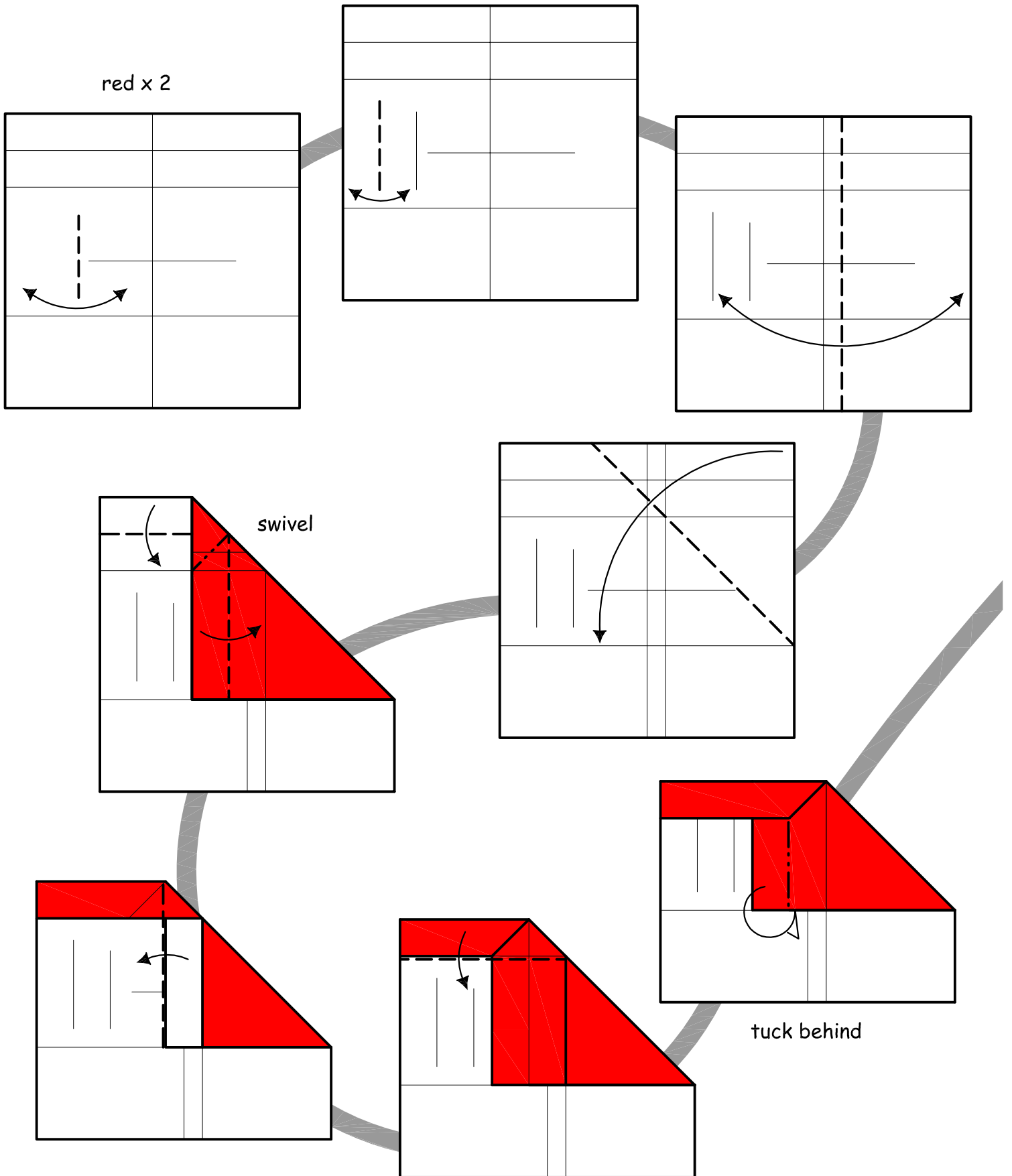

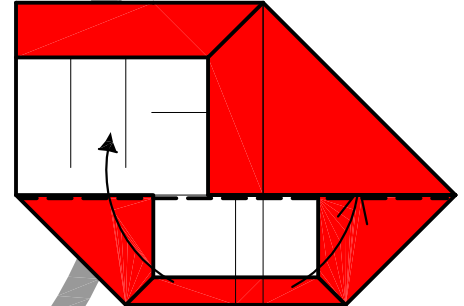
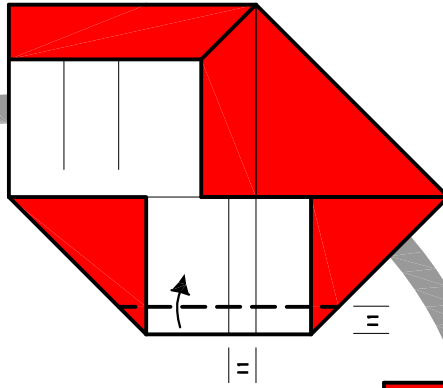
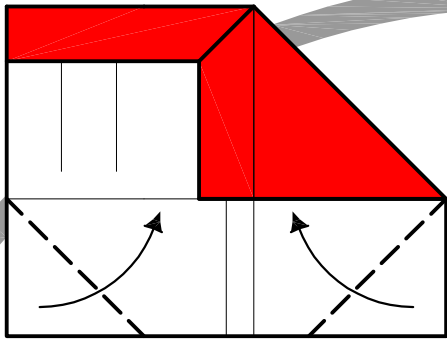

tuck inside

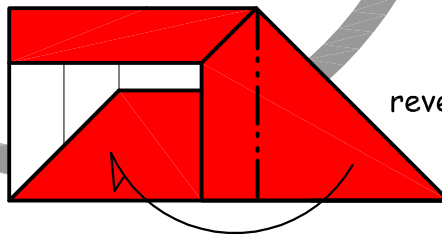
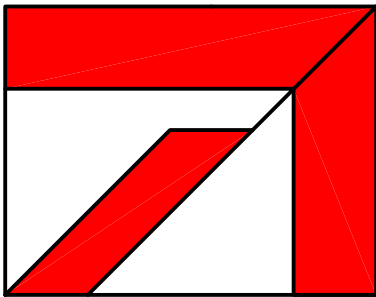

reverse

bottom left and top right module completed two required

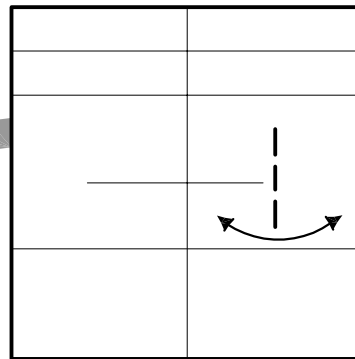
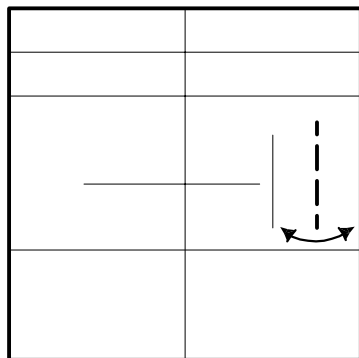

use a mirror sequence to fold the other two modules. see page 2

red x 2

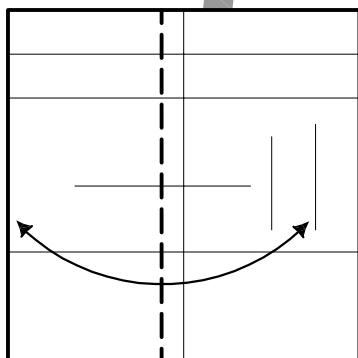

(St. George and St. Patrick's Crosses)

and so on.....

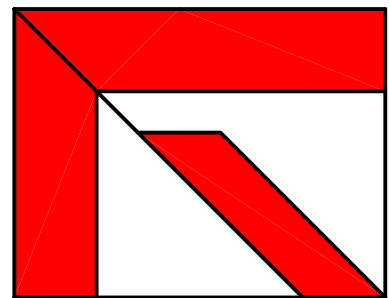

bottom right and top left module completed two required

(St. Andrew's Cross)

blue squares x 4
white side up

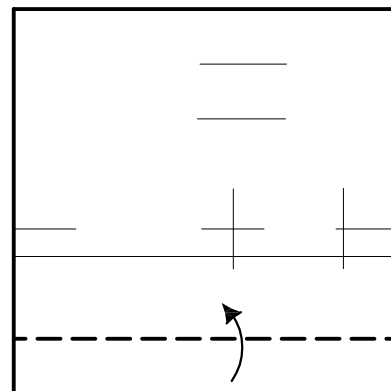
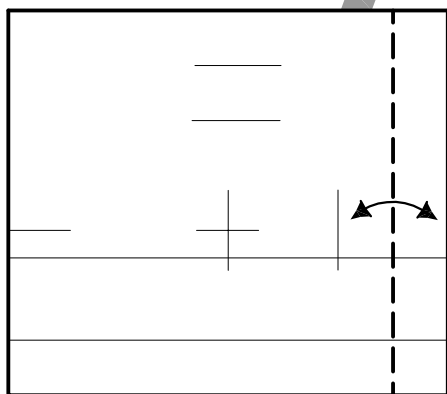
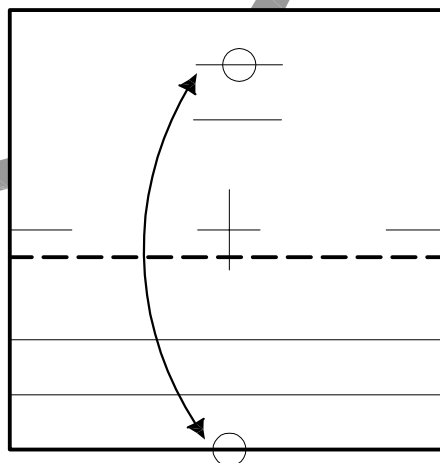
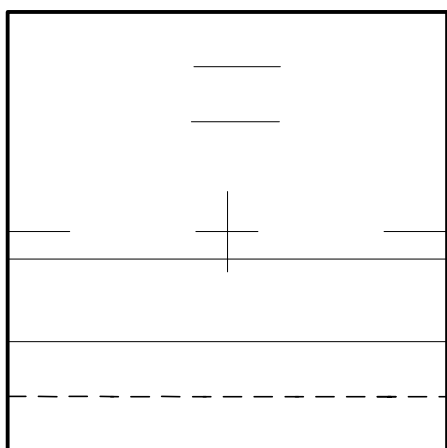
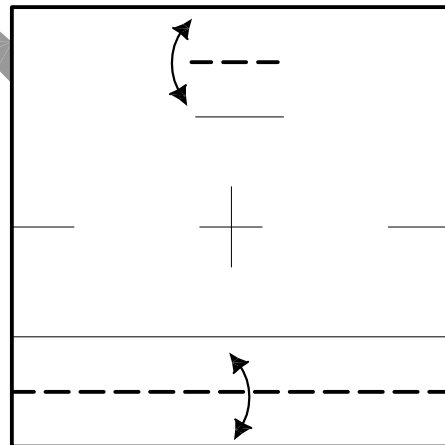
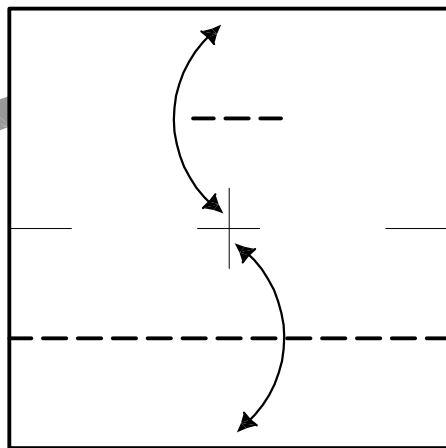
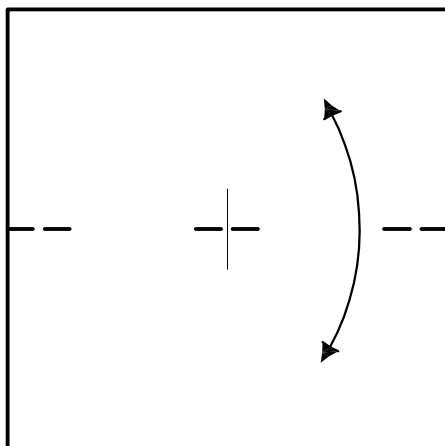

repeat the bottom
steps on the right
hand side, but don't
fully crease at the
quarter mark

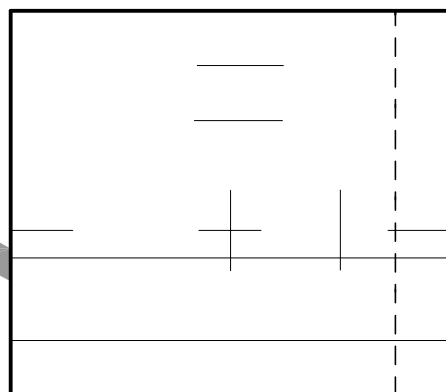

trim back to a square



(St. Andrew's Cross)

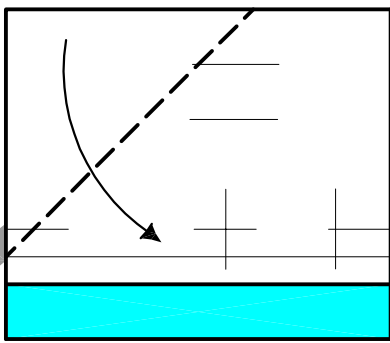

x 2

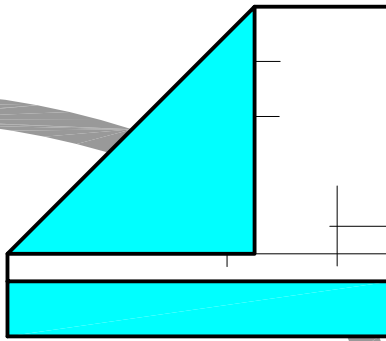

completed

for assembly with
bottom left and top
right two required

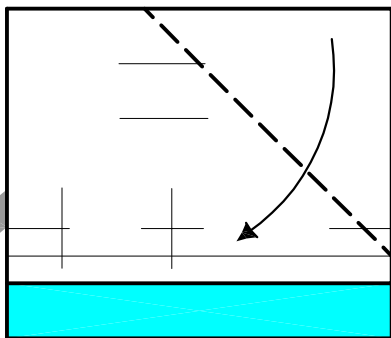
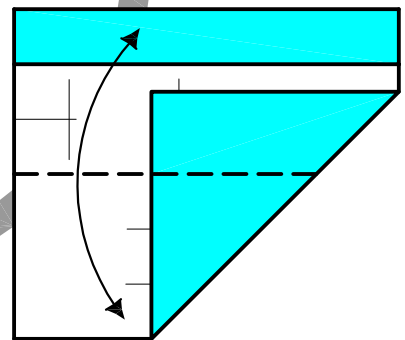
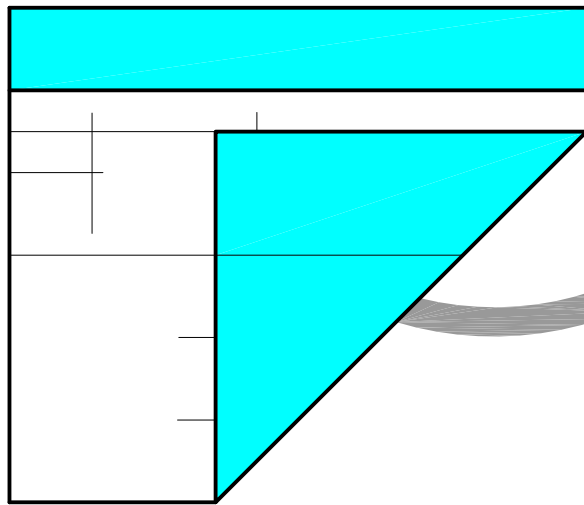

x 2

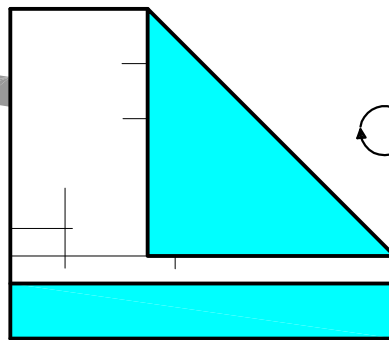

completed

for assembly with
bottom right and top
left two required

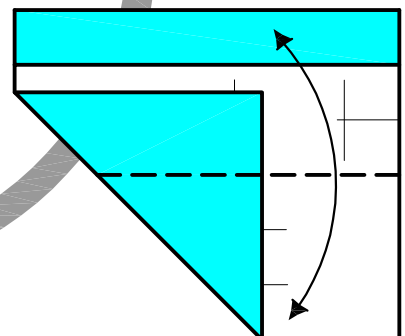
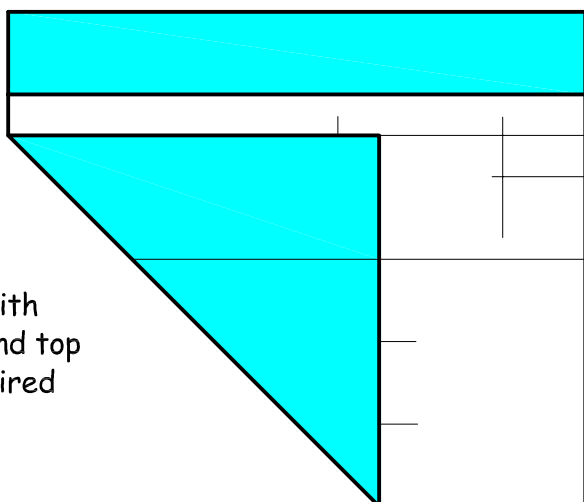

ASSEMBLY

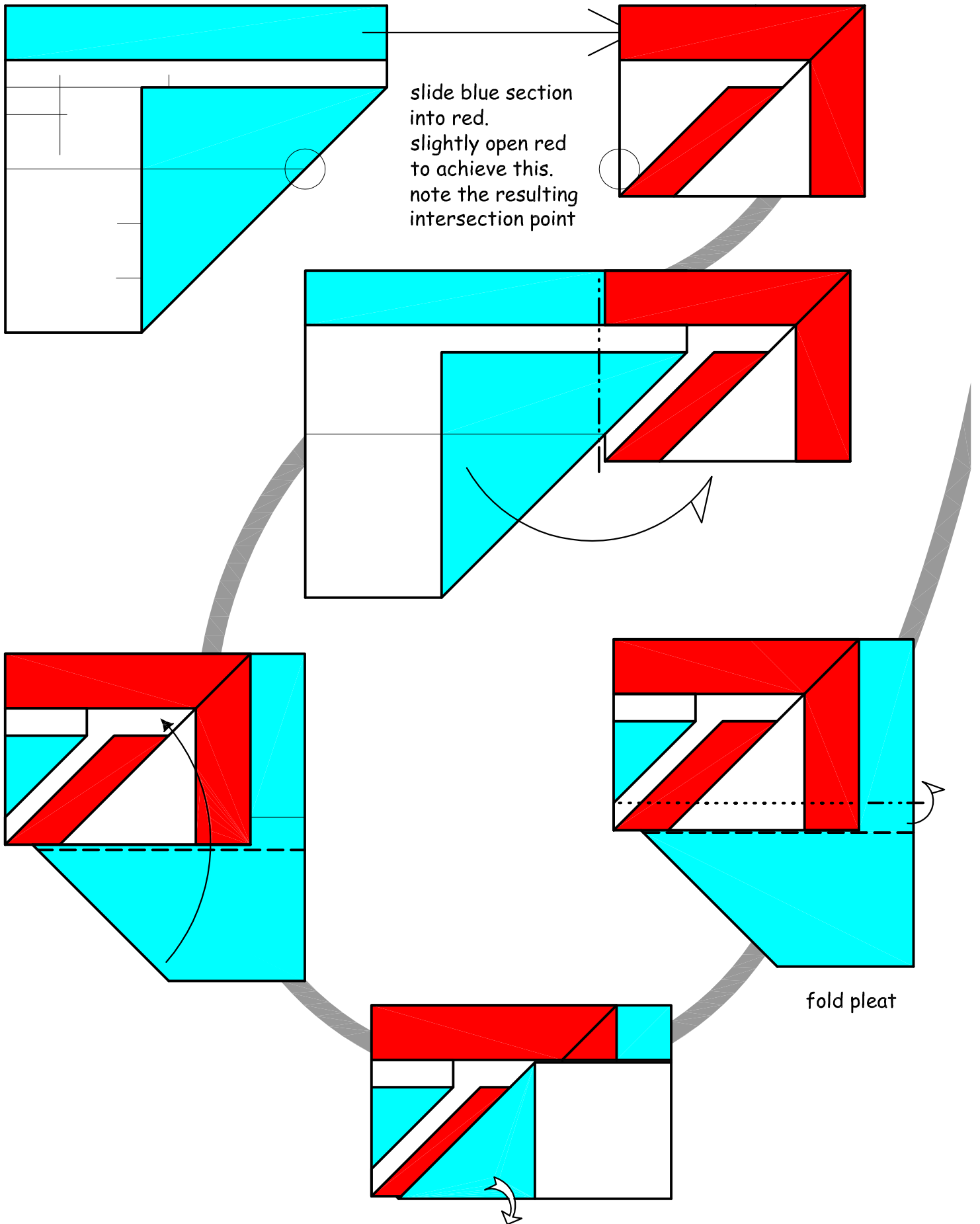

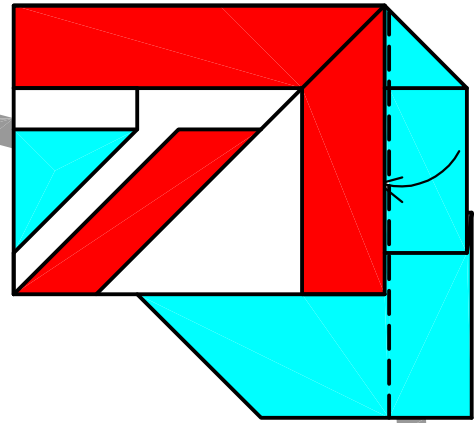
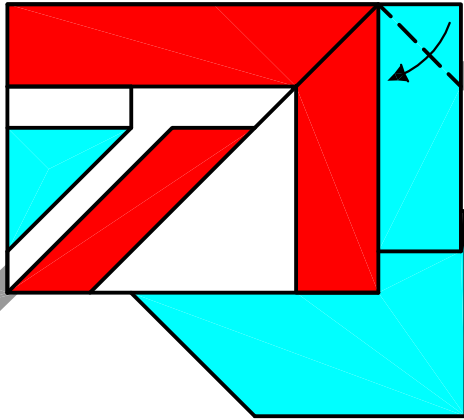

tuck inside

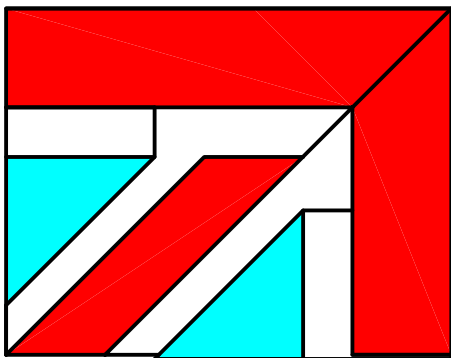

completed
two required

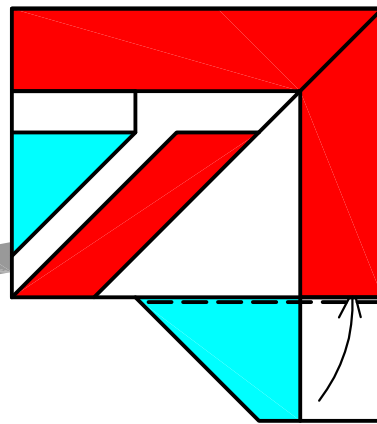

tuck
inside

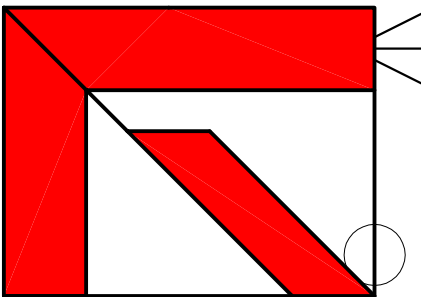

use a mirror
sequence to
assemble the
other two
modules.

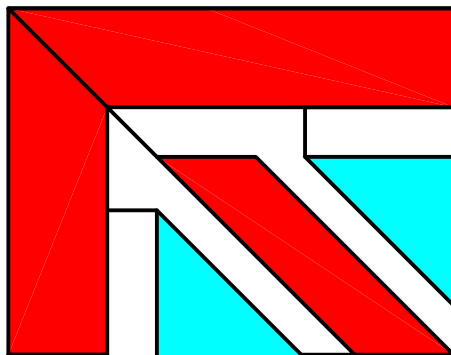
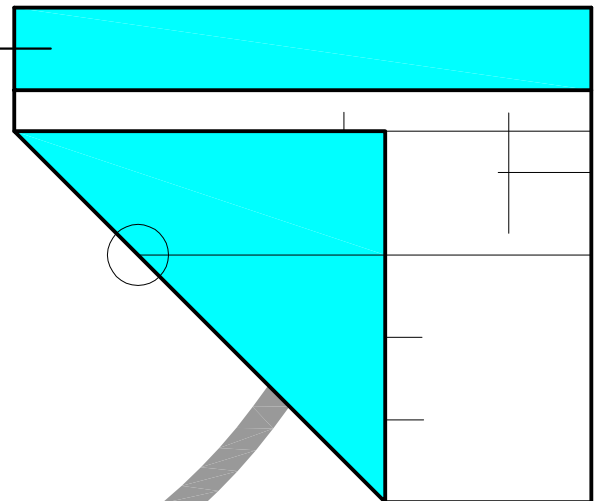

completed
two required